



4" Spin Klin™ Galaxy

Automatic disc
filtration system

MASTERS OF FILTRATION



Any Technology



Anywhere



Any Challenge

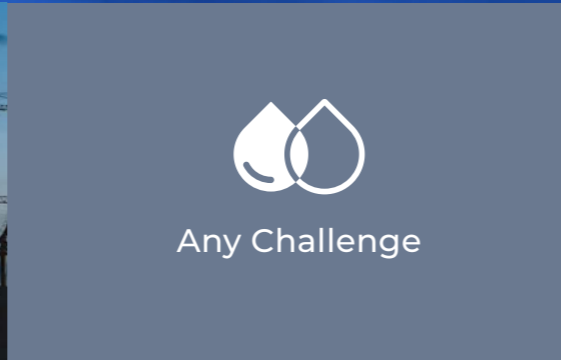

Any Water Source



Your water challenge.
Our filtration solution.

Amiad Water Systems is a world leader in water treatment and filtration solutions. For over 57 years Amiad has devoted its passion and commitment to developing a comprehensive line of water filtration systems for a wide range of industrial applications.

Our solutions are integrated into the core of water filtration systems in the following industries and applications: metal, plastic, energy, chemical, water treatment and salt water disposal.

We develop filters that are able to cope with any water quality, in any geographical location.

We've spent years mastering filtration technology so we can offer a wide range of filters for every industrial need, including screen, disc, microfiber or media technology.

We consider every challenge as an opportunity to work side by side with our customers to solve their problems.

We'll go anywhere to ensure our filters perform as expected, 24/7, every day of the year.

When you want a high-performance solution for your water filtration system, consult with Amiad. We focus on doing what we do best.

Amiad. Masters of Filtration.



Disc
Technology



Screen
Technology



Media
Technology



Microfiber
Technology

SPIN KLIN™ GALAXY FEATURES

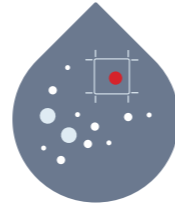

Micron-precise depth
filtration of solids



Reliable and durable



Polymeric

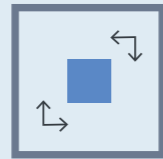

Compact design



Low water and energy
consumption



Minimal maintenance



Scan to watch the
Spin Klin™ Operation
Video

4" SPIN KLIN™ Galaxy: Modular Depth Filtration

4" Spin Klin™ Galaxy Spine Technology



Galaxy pod

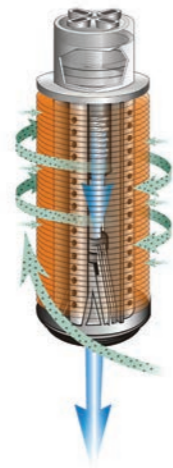

Filtration mode

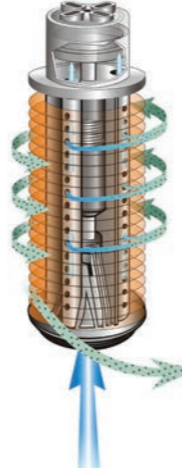

Backwash mode

Disc material type availability according to filtration degree:

10	20	40	55	70	100	130	200	400
PP	PP, PA	PP, PA	PP, PA	PP, PA	PP, PA	PP, PA	PP, PA	PP

PP = Polypropylene disc **PA** = Nylon disc

4" Spin Klin™ Galaxy Battery Installation



Construction materials	
Filter housing & lid	PP (Polypropylene)
Disc elements	PP (Polypropylene) or PA (Polyamide)
Backwash valves	RPA (Reinforce Polyamide)
Manifolds	PP (Polypropylene)
Seals	NBR or EPDM, (Viton optional)
Control tubing	PE or PA

4" SPIN KLIN™ Galaxy: Models

4" Spin Klin™ Galaxy



Head Loss Graphs (in clean water)

3 x 4" Spin Klin™ Galaxy Battery

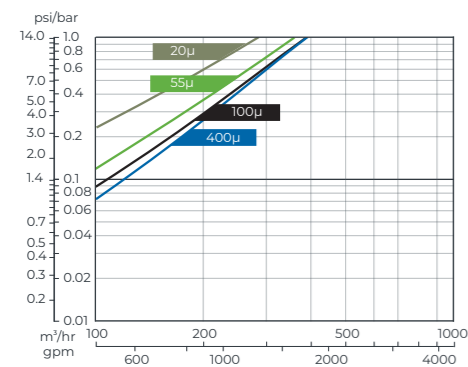

4 x 4" Spin Klin™ Galaxy Battery

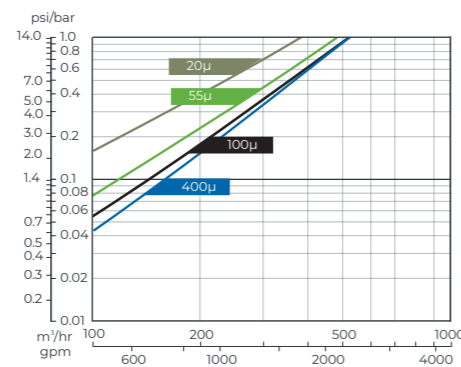

5 x 4" Spin Klin™ Galaxy Battery

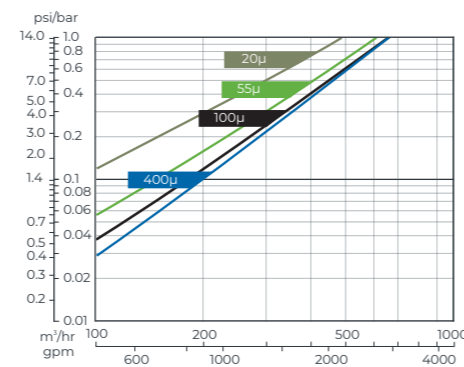

6 x 4" Spin Klin™ Galaxy Battery

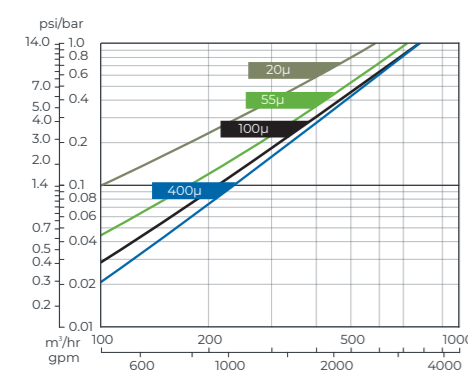

7 x 4" Spin Klin™ Galaxy Battery

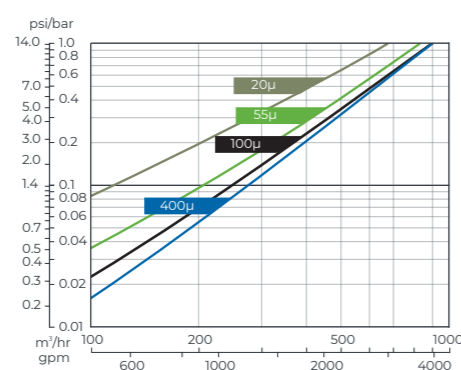

8 x 4" Spin Klin™ Galaxy Battery

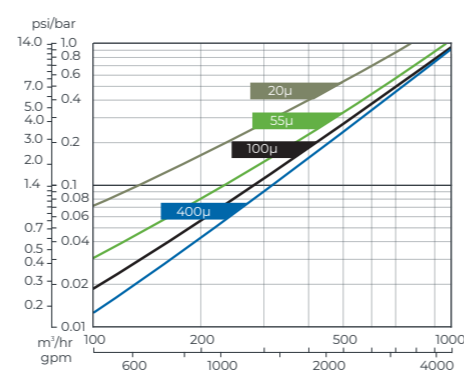

Filter Type	3 unit battery	4 unit battery	5 unit battery	6 unit battery	7 unit battery	8 unit battery
-------------	----------------	----------------	----------------	----------------	----------------	----------------

General Data

Max. operating pressure*	10 bar (145 psi)						
Min. backwash pressure	400-100µ	2.8 bar (40 psi)					
	55-20µ	4-5 bar (58 - 72 psi)					
Max. recommended flow rate	100µ	225 m³/h (990 gpm)	300 m³/h (1,320 gpm)	375 m³/h (1,650 gpm)	450 m³/h (1,980 gpm)	525 m³/h (2,310 gpm)	600 m³/h (2,642 gpm)
	55µ	150 m³/h (660 gpm)	200 m³/h (880 gpm)	250 m³/h (1,101 gpm)	300 m³/h (1,321 gpm)	350 m³/h (1,541 gpm)	400 m³/h (1,761 gpm)
	20µ	75 m³/h (330 gpm)	100 m³/h (440 gpm)	125 m³/h (550 gpm)	150 m³/h (660 gpm)	175 m³/h (770 gpm)	225 m³/h (990 gpm)
Available filtration degrees	400, 200, 130, 100, 70, 55, 40, 20, 10 micron						
Filtration volume	17,219 cm³ (1,051 in³)	22,959 cm³ (1,401 in³)	28,698 cm³ (1,751 in³)	34,438 cm³ (2,101 in³)	40,177 cm³ (2,451 in³)	45,918 cm³ (2,802 in³)	
Inlet/outlet diameter	200 mm (8")	280 mm (10")		315 mm (12")		355 mm (14")	
Max. working temperature*	60°C (140°F)						
Dry weight standard	270 kg (594 lb)	350 kg (770 lb)	440 kg (968 lb)	530 kg (1,166 lb)	670 kg (1,447 lb)	770 kg (1,694 lb)	

*Maximum operating pressure and temperature are interdependent parameters and are given for general reference only. Please consult your authorized Amiad representative for the application specific parameters.

Backwash Data

Drain connection	110 mm (4")
Flushing time	20 seconds
Min. flow for backwash	50 m³/h (220 gpm)

Typical Installation Drawing

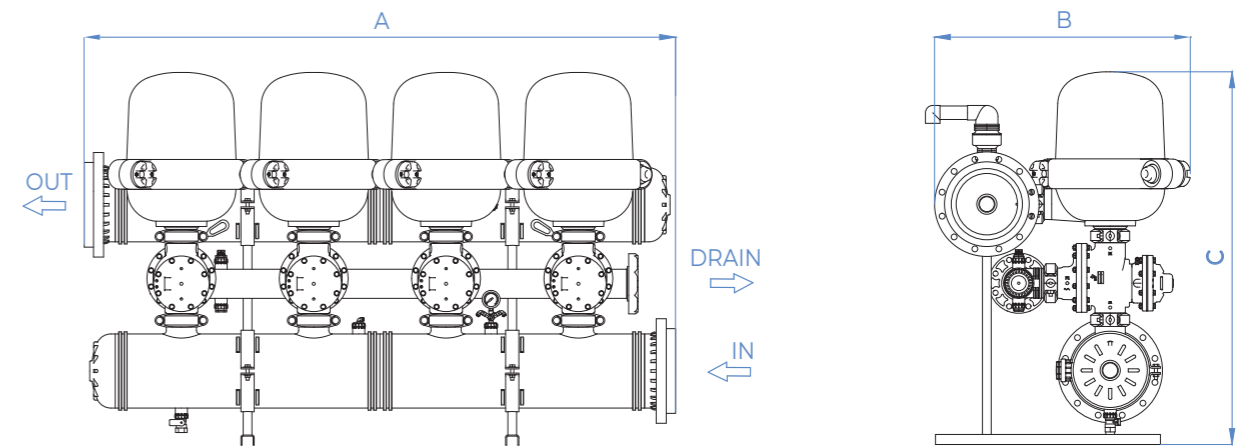

Dimensions		3 unit battery	4 unit battery	5 unit battery	6 unit battery	7 unit battery	8 unit battery
A	Length	1,664 mm (65 1/2")	2,234 mm (87 15/16")	2,734 mm (107 5/8")	3,234 mm (127 5/16")	3,734 mm (147")	4,234 mm (166 11/16")
B	Width	940 - 980 mm (35 7/16" - 38 9/16")					
C	Height	1,370 mm (53 15/16")		1,408 mm (55 7/16")		1,466 mm (57 23/32")	

4" SPIN KLIN™ Galaxy: Models

4" Spin Klin™ Galaxy External Source



Head Loss Graphs (in clean water)

3 x 4" Spin Klin™ Galaxy
Battery External Source

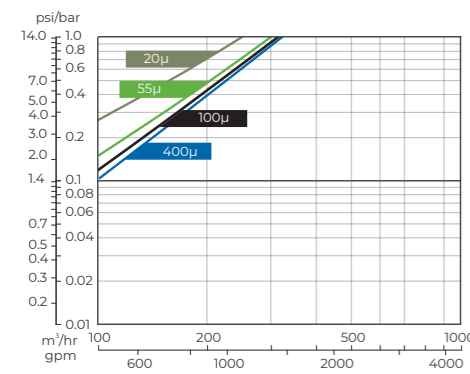

4 x 4" Spin Klin™ Galaxy
Battery External Source

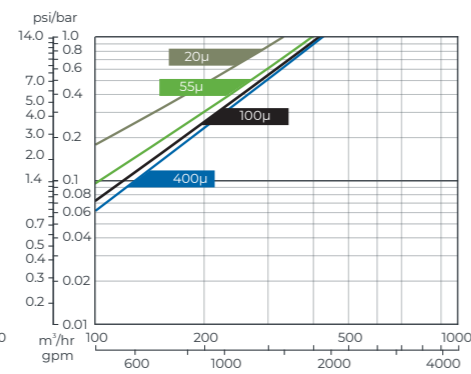

5 x 4" Spin Klin™ Galaxy
Battery External Source

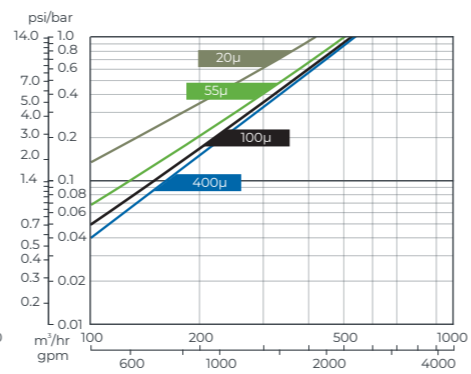

6 x 4" Spin Klin™ Galaxy
Battery External Source

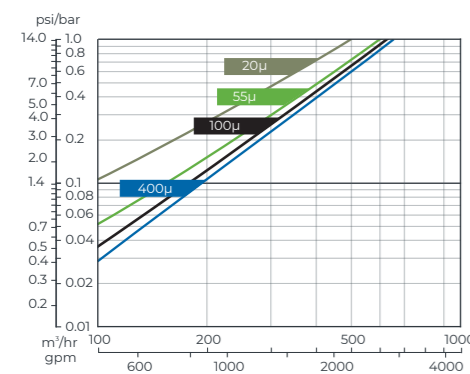

7 x 4" Spin Klin™ Galaxy
Battery External Source

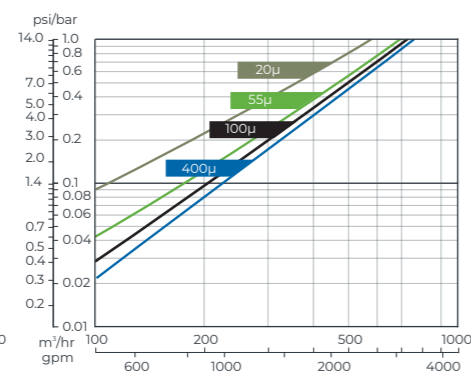

8 x 4" Spin Klin™ Galaxy
Battery External Source

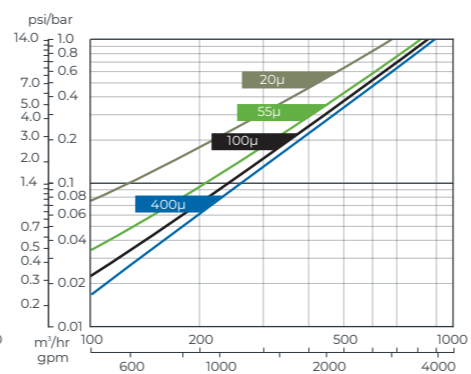

Filter Type	3 unit battery	4 unit battery	5 unit battery	6 unit battery	7 unit battery	8 unit battery	
General Data							
Max. operating pressure*	10 bar (145 psi)						
Min. backwash pressure	400-100µ	2.8 bar (40 psi)					
	55-20µ	4-5 bar (58 - 72 psi)					
Max. recommended flow rate	100µ	225 m³/h (990 gpm)	300 m³/h (1,320 gpm)	375 m³/h (1,650 gpm)	450 m³/h (1,980 gpm)	525 m³/h (2,310 gpm)	600 m³/h (2,642 gpm)
	55µ	150 m³/h (660 gpm)	200 m³/h (880 gpm)	250 m³/h (1,101 gpm)	300 m³/h (1,321 gpm)	350 m³/h (1,541 gpm)	400 m³/h (1,761 gpm)
	20µ	75 m³/h (330 gpm)	100 m³/h (440 gpm)	125 m³/h (550 gpm)	150 m³/h (660 gpm)	175 m³/h (770 gpm)	225 m³/h (990 gpm)
Available filtration degrees	400, 200, 130, 100, 70, 55, 40, 20, 10 micron						
Filtration volume	17,219 cm³ (1,051 in³)	22,959 cm³ (1,401 in³)	28,698 cm³ (1,751 in³)	34,438 cm³ (2,101 in³)	40,177 cm³ (2,451 in³)	45,918 cm³ (2,802 in³)	
Inlet/outlet diameter	200 mm (8")	280 mm (10")		315 mm (12")		355 mm (14")	
Max. working temperature*	60°C (140°F)						
Dry weight external source backwash	340 kg (748 lb)	440 kg (968 lb)	550 kg (1,210 lb)	650 kg (1,430 lb)	810 kg (1,782 lb)	920 kg (2,024 lb)	

*Maximum operating pressure and temperature are interdependent parameters and are given for general reference only. Please consult your authorized Amiad representative for the application specific parameters.

Backwash Data

Drain connection	110 mm (4")
Flushing time	20 seconds
Min. flow for backwash	50 m³/h (220 gpm)

Typical Installation Drawing

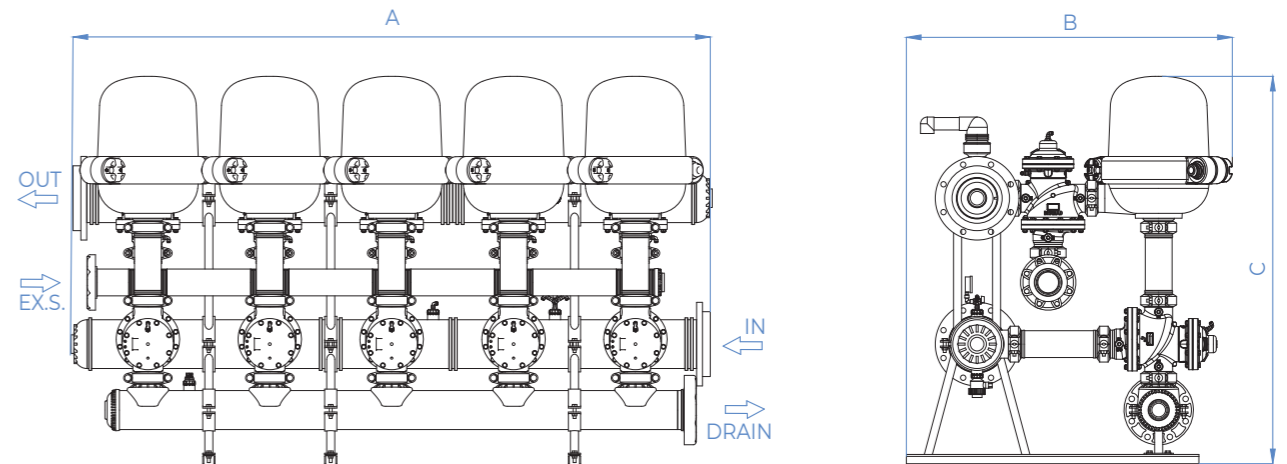

Dimensions		3 unit battery	4 unit battery	5 unit battery	6 unit battery	7 unit battery	8 unit battery
A	Length	1,664 mm (65 1/2")	2,234 mm (87 15/16")	2,734mm (107 5/8")	3,234 mm (127 5/16")	3,734 mm (147")	4,234 mm (166 11/16")
B	Width	1,352 mm (53 7/32")					
C	Height	1,590 mm (62 19/32")					

Note: All dimensions are for reference only. Certified drawings are available upon request.



Headquarters

Amiad Water Systems Ltd.

Web: www.amiad.com

E-mail: info@amiad.com

The Americas

USA

Amiad USA Inc.

Web: us.amiad.com | E-mail: infousa@amiad.com

Mexico

Amiad México SA DE CV,

Web: es.amiad.com | E-mail: infomexico@amiad.com

Asia

India

Amiad Filtration India Pvt Limited

Web: amiad.com | E-mail: info-india@amiad.com

China

Amiad China (Yixing Taixing Environtec Co., Ltd.)

Web: cn.amiad.com | E-mail: infochina@amiad.com

South-East Asia

Filtration & Control Systems Pte. Ltd.

Web: amiad.com | E-mail: info-singapore@amiad.com

Australia

Amiad Australia Pty Ltd.

Web: au.amiad.com | E-mail: sales@amiad.com

Europe

Amiad Water Systems Europe SAS

Web: amiad.com | E-mail: industry-europe@amiad.com

German branch office

Web: de.amiad.com | E-mail: industry-de@amiad.com

United Kingdom

Amiad Water Systems UK Limited

Web: amiad.com | E-mail: info-uk@amiad.com



 **amiad** INDUSTRY

MASTERS OF FILTRATION

www.amiad.com

910101-000565/05.2022

Copyright © 2019 Amiad Water Systems Ltd. All rights reserved. The contents of this catalogue including without limitation all information and materials, images, illustrations, designs, icons, photographs, graphical presentations, designs, literary works, data, drawings, slogans, phrases, names, trademarks, titles and any other such materials that appear in this catalogue (collectively, the "Contents") are the sole property of Amiad Water Systems Ltd. ("Amiad"). Amiad has sole and exclusive right, title and interest in the Contents, including any intellectual property rights, whether registered or not, and all know-how contained or embodied therein. You may not reproduce, publish, transmit, distribute, display, modify, create derivative works from, sell or participate in any sale of, or exploit in any way, in whole or in part, any of the Contents or the catalogue. Any use of the catalogue or the Contents, other than for personal use, requires the advanced written permission of Amiad.