

AMIAD WATER SYSTEMS Ltd.

Arkal Spin Klin™ 2" with Air Aid Flushing (AAF)

User Guide

Serial number:	_____
Order number:	_____
Catalog number:	_____
Filtration degree:	_____
Tested by:	_____

Installation and Operation Instructions

910101-000616 / 06.2021

AMIAD WATER SYSTEMS Ltd.

Arkal Spin Klin 2" AAF - Service & Maintenance Manual



Disclaimer:

Copyright © 2017 Amiad Water Systems Ltd. All rights reserved.

The contents of this document, including without limitation all information and materials, images, illustrations, data, drawings, names and any other such materials that appear in this document are the sole property of Amiad Water Systems Ltd., including any intellectual property rights, whether registered or not, and all know-how contained or embodied therein. Amiad may alter, remove or change the Content without any further notice. You may not reproduce, copy, modify, create derivative works from, sell or participate in any sale of, or exploit in any way, in whole or in part, any of this document or its content.

The confidential nature of and/or privilege in the file enclosed is not waived or lost as a result of a mistake or error in this file. If you received this file in error, please notify Amiad immediately at info@amiad.com.

This document does not replace any certified drawing, procedure or information provided by Amiad in reference to a specific customer, site or project.

Amiad assumes that all users understand risks involved within this file and/or its attached materials. This document is given in good faith and is not intended to impose any obligation to Amiad. While every effort has been made to ensure the information in this manual is accurate and complete, we would appreciate if you can bring any errors or omissions to the knowledge of Amiad or consult Amiad experts or its authorized representatives if you have any questions.

Amiad Water Systems Ltd. D.N. Galil Elyon 1, 1233500, Israel Tel: 972 4 690 9500 | Fax: 972 4 814 1159 Email: info@amiad.com

Table of Contents

1. Introduction.....	4
2. Safety Instructions.....	4
3. Description & Operation	7
4. Technical Data.....	11
5. Dimensional Drawing.....	12
6. Installation & Start-up.....	13
7. System Maintenance	14
8. Troubleshooting	19
9. Control Scheme	21
10. FILTER PARTS SCHEDULE AND PARTS LIST	22
11. VALVES - PARTS SCHEDULE AND PARTS LIST	23
12. SYSTEM DRAWINGS (to be amended per each specific ordered)	28
13. AMIAD LIMITED WARRANTY	29

1. Introduction

General:

Amiad Water Systems congratulates you on purchasing our new Arkal Spin Klin Filtration System. All Arkal filters are easy to install, use and service and require no special skills to operate. For operation and maintenance of this filter please follow the instructions in this manual. This Arkal Spin Klin battery system is an automatic self-cleaning filter designed for non-hazardous liquids only and for operation within the pressure framework described in the specifications table.

2. Safety Instructions

2.1 General Safety Instructions:

- The manufacturer filtration products always operate as components in a larger system. It is essential for the system designers, installers and operators to comply with all the relevant safety standards.
- Prior to installation, operation, maintenance or any other type of action carried out on the filter, read carefully the installation and operation instructions.
- During installation, operation or maintenance of the filter all conventional safety instructions should be observed in order to avoid danger to the workers, the public or to property in the vicinity.
- The system has to be used for non-hazardous liquids only!
- Please note: The filter enters into a flushing mode automatically, without prior warning.
- No change or modification to the equipment is permitted without a written notification given by the manufacturer or by its representative, on the manufacturer's behalf.
- Always observe standard safety instructions and good engineering practices whilst working in the filter's vicinity.
- Use the filter only for its intended use as designed by the manufacturer, any misuse of the filter may lead to undesired damage and may affect your warranty coverage. Please consult with the manufacturer prior to any non-regular use of this equipment.
- System's cleaning and maintenance shall be carried out only when explosive atmosphere is not present!

2.2 General Installation:

- Install the filter according to the detailed Installation Instructions provided with the filter by the manufacturer and according to the description given in this manual.
- Make sure to leave enough clearance, side and top, so as to enable easy access for future treatments and safe maintenance operations.
- The user should arrange suitable lighting at the area of the filter to enable good visibility and safe maintenance.
- The user should arrange suitable platforms and safety barriers to enable easy and safe access to the filter without climbing on pipes and other equipment. The user should verify that any platform, barrier, ladder or other such equipment is built, installed and used in accordance with the relevant local authorized standards.
- Check and re-tighten all bolts during commissioning and after the first week of operation.
- Use only appropriate standard tools and equipment operated by qualified operators when installing, operating and maintaining the filter.
- When installation is required in hazardous environment sites, underground or high above ground, make sure that the site design and the auxiliary equipment are appropriate and that installation procedures are carried out in accordance with the relevant standards and regulations.
- Ensure walking areas about the installation are slip free when wet.

- It is recommended to stabilize the drain pipe that might vibrate during flushing mode.

2.3 Shipment and transporting:

- Shipping and transporting the filter must be done in a safe and stable manner and in accordance with the relevant standards and regulations.
- For shipping, lifting and positioning the filter, use only approved lifting equipment and authorized employees and contractors.

2.4 Electricity:

- Electric wiring should be performed by an authorized electrician only, using standardized and approved components.
- The system must be installed with suitable electrical grounding that would prevent any electrostatic discharge from the system.
- Install a **lockable** main power cut-off switch close to the control panel.
- If due to site constraints, the control panel is installed without a clear line-of sight of the filter, an additional **lockable** power disconnect cut-off switch should be installed near each filter unit.
- Installation of the filter should be performed so as to avoid direct water splashing on the electrical components or on the control panel.

2.5 Pneumatics:

- Install a **lockable** main cut-off switch, **featured with a pressure release mechanism**, on the compressed air supply line close to the control panel.
- Install non return valve before the compressed air valve on the accumulator tank.
- If the control panel is installed far away and there is no eye contact with the filter, a **lockable** compressed air cut-off switch, **featured with a pressure release mechanism**, should be installed near each filter unit.
- The user should make sure that the compressed air supplied to the filter never exceeds the maximum designated pressure for this filter. An air-pressure reduction valve should be installed on the compressed air supply line upstream of the filter's pneumatic inlet port.

2.6 Hydraulics:

- Extra safety devices should be installed on hot water applications to avoid skin burn danger.
- The user should install a manual Water Cut-off Valve next to the filter's inlet port.
- In cases where the downstream piping network downstream of the filter is pressurized an additional manual Water Cut-off Valve should be installed next to the filter outlet port.
- The user should make sure that the system includes a Pressure Release / Drainage Valve to enable release of residual pressure prior to any maintenance procedure performed on the filter.
- The user should make sure that the filter is never exposed to water pressure exceeding the maximum designated pressure for this filter, if needed a Pressure Reduction Valve should be installed upstream of the filter's water inlet port.
- Please note that the maximum working pressure indicated at the filter's specifications table includes the pressure caused by fluid hammer and pressure surge effects.

2.7 Civil Engineering:

- Make sure that the filter installation is done by the manufacturer qualified technicians.
- Make sure that any civil engineering work at the installation site such as construction, lifting, welding, etc. is done by qualified workers / technicians / contractors and in accordance with the relevant local standards.
- While using lifting equipment, make sure that the filter or the lifted part is chained securely and in a safe manner.
- Do not leave lifted equipment if there is no necessity. Avoid working below lifted equipment.
- Wear a safety helmet while using lifting equipment.
- Make sure that the flooring is sloped to for drainage and to avoid accumulation of liquids.

2.8 Commissioning:

- Read carefully the Commissioning and the First Start-up Operation instructions prior to any attempt to operate the filter.
- In order to achieve maximum performance and smooth operation of the filter it is crucial to perform the startup and first operation procedures exactly as described in this manual.
- Commissioning the filter should be done by an authorized the manufacturer technician, do not attempt to commission the filter unaccompanied since this may lead to undesired damage and may affect your warranty coverage.

2.9 Operation and Control:

- Do not operate the filter before reading carefully and being familiar with its operation instructions.
- Observe the safety stickers on the filter and never perform any operation contradicting the instructions given.
- Never operate or use the filter for purposes other than its original design and operational envelope.
- The system must be used for nonhazardous liquids only!
- System's cleaning and maintenance shall be carried out only when explosive atmosphere is not present!

2.10 Maintenance:

- Servicing the filter should be done only by technicians authorized by the manufacturer.
- System's cleaning and maintenance shall be carried out only when explosive atmosphere is not present!
- Disconnect the filter from the power supply and lock the Main Power Switch.
- Disconnect the compressed air supply, release the residual pressure and lock the Pneumatics Main Valve.
- Disconnect the filter from the water system by closing and securing the manual inlet valve. In cases where the downstream piping network is pressurized, close and secure the manual outlet valve also.
- Release the residual water pressure by opening the pressure release / drainage valve.
- Empty the filter by opening the drainage valve.
- In hot water systems wait till the filter components cool off to a safe temperature.
- Place warning signs around the work area as required by the local standards and procedures.
- Inspect the filter's safety stickers and replace any damaged or faded sticker.

ATTENTION! - Before opening the filter lock, check that there is no pressure in the filter and in the accumulator tank.

3. Description & Operation

3.1 Disc Filtration Technology:

Amiad Filtration Systems uses a specially designed disc filtration technology. Thin, color-coded polymeric discs are diagonally grooved on both sides to a specific micron size. A series of these discs are then stacked and compressed on a specially designed spine. When stacked, the groove on top runs opposite to the groove below, creating a filtration element with a statistically significant series of grooves and traps for solids. The stack is enclosed in corrosion and pressure resistant housing.

During the filtration process, the filtration discs are tightly compressed together by the spring's power and the differential pressure, thus providing high filtration efficiency. Filtration occurs while water is percolated from the outer diameter to the inner diameter of the element. Depending on the micron rating, there are from 18 (in 400 micron discs) to 32 (in 20 micron discs) stopping points in each track, thus creating the unique in-depth filtration.

Table of Filtration Grades of the Discs and Color Code

Color Code	Light Blue	Gray	Purple	Green	Brown	Black	Red	Yellow	Blue
Micron	10	20	40	55	70	100	130	200	400
PP / PA (Nylon)	PP	PP, PA	PP	PP, PA	PP, PA	PP, PA	PP, PA	PP, PA	PP

***PP discs are standard Arkal, PA discs available on request**

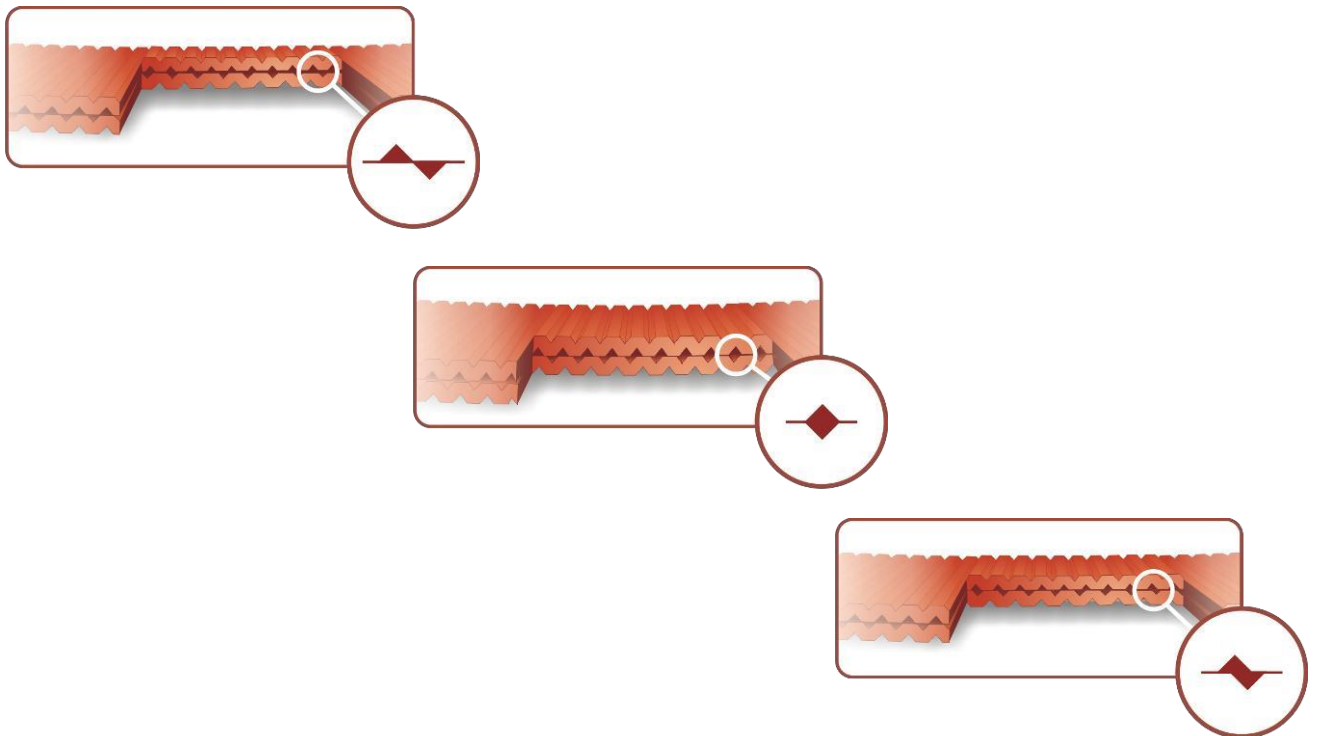

3.2 Spin Klin Technology:

Spin Klin Spine - The Core of the Spin Klin Filtration System

The Spin Klin discs are stacked on the Spin Klin Spine. The discs are color-coded according to micron size, and are assembled to suit your water filtration requirements. The spine assembly has a spring compression unit and an internal Piston, which operate during alternate filtration or back-flush modes. Inside the housing a spring and the pressure difference compress the discs tightly during the filtration process, forcing the water to flow between the grooves on the discs and trap the solids.



Spin Klin Automatic Back-flush Operation

Activated by an external command (differential pressure or time) alternate units of the Spin Klin system go into back-flush mode. During the back-flush mode, the compression spring is released and the pressure difference is eliminated. The spine piston rises up, releasing the pressure on the discs. Tangential jets of clean water are sprayed at high pressure through the nozzles of the spine at the discs. The discs spin freely loosening the trapped solids that quickly and efficiently washed out through the drain.

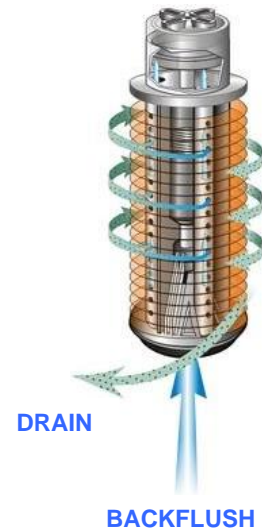

3.3 Back-flush Valves Operation Mode:

Modes of the filter's Control valve

Filtration Position:

- **Inlet valve** - Water flows from port [2] (main supply) to port [C] (filter connection). Port [1] (drain water outlet) is closed by the seal.
- **Outlet valve** - Water flows from port [C] to port [2]. Port [1] is closed by the seal.

Back-flush Position:

- **Inlet valve** - Command pressure is applied to the diaphragm's control chamber through port [D]. The diaphragm moves the sealed shaft, port [2] closes, preventing flow to the filter. Port [C] opens, allowing flushing water to flow from port [C] (filter connection) to the drain [1].
- **Outlet valve** - Command pressure is applied to the diaphragm's control chamber through port [D]. The diaphragm moves the sealed shaft, port [2] closes, port [1] opens, allowing flushing water to flow to port [C].

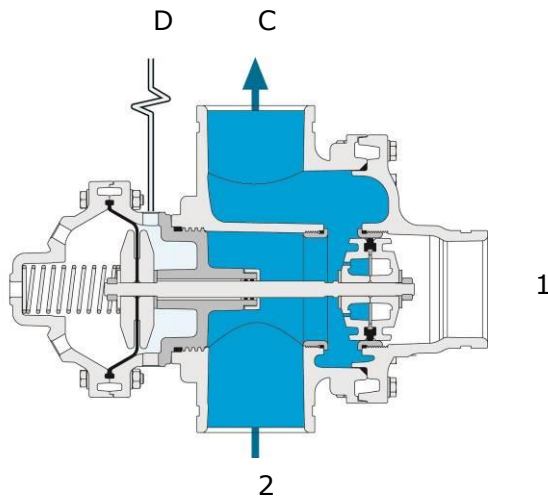

Inlet Valve Filtration Mode

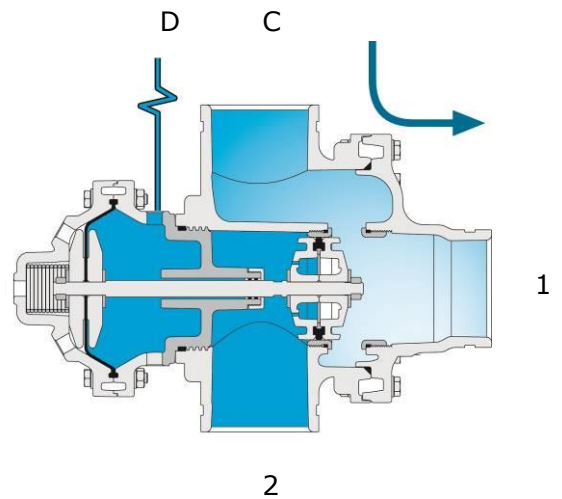

Inlet Valve Back-flush Mode

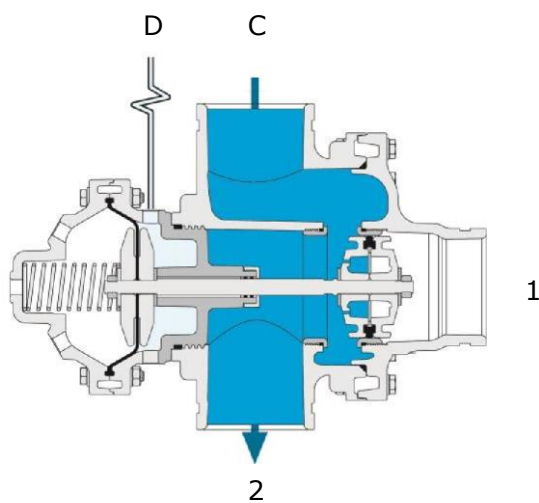

Outlet Valve Filtration Mode

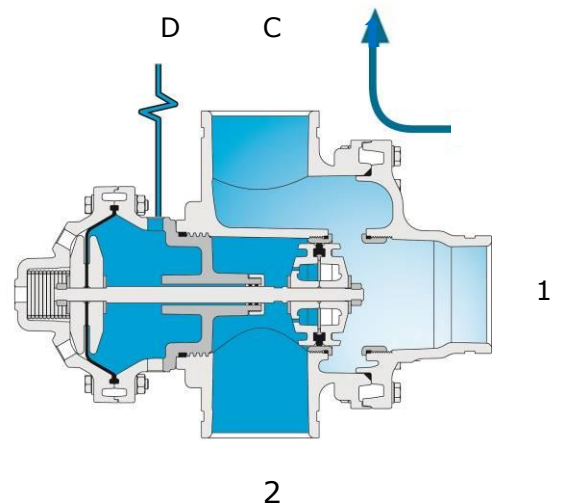

Outlet Valve Back-flush Mode

3.4 Mode of Operation

Filtration Process

- During the filtration stage water flows through the Inlet Manifold, distributing through the Straight flow Valve to the 2" Spin Klin Filter.
- The water passes through the Filters Filtration Elements Cleaned and flows out through the Straight flow Valve to the Outlet Manifold and to the customer.
- At this stage the Accumulator Tank fills up with clean water from the Outlet Manifold through its Check Valve.

Back-flushing Process

1. The Controller/PLC transmits an electric signal to solenoid No.1 (as per pressure differential set point reach, time set-up or manually whichever comes first).
2. Command from solenoid No. 1 simultaneously flow to the valves of filter No.1:
 - a. To the INLET VALVE (Straight Flow) converting it from filtration mode to back-flush mode.
 - b. To the OUTLET VALVE (Straight Reverse Flow) converting it from filtration mode to back-flush mode.
3. After Pre-set Valve delay time the Controller/PLC transmits an electric signal to the Valve Delay Solenoid.
4. Command from the Valve delay solenoid simultaneously flow to the Accumulator Tank valves:
 - a. To the Air Valve, allowing the compressed Air to enter the Accumulator Tank.
 - b. To the Check Valve to close the connection to the outlet manifold.
5. The Compressed Air enters the Accumulator Tank and increase the water pressure in it to the pressure of the Compressed Air.
6. The Air is mixed with clean water and is carried to Filter No.1 which is then Back-flushed.
*The ratio between Air and water will rise until there is hardly any water at termination (air alone does not spin the discs).
7. At the end time of the Back-flush the Controller/PLC release the command first of the Valve delay Solenoid then after the same delay time as paragraph 3 to the Solenoid No.1.
8. The Accumulator Tank need to fill up with clean water before the next filter can be back-flushed, about 20 – 25 seconds will be enough.
9. When the Accumulator Tank is filled up the controller will start back-flush the next filter until all the filters are clean.

4. Technical Data

Parameters	METRIC	US
Maximum pressure	10 bar (25° C) (Depending on the filter material RPP or RPA)	145 psi (77 °F) (Depending on the filter material RPP or RPA)
Minimum working pressure	0.8 bar	11.6 psi
Back-flush water volume	12 – 22 (L) Per single filter	3.2 – 5.8 (Gl) Per single filter
Maximum temperature	60 °C (@4 bar)	158 °F (@58 psi)
PH	4-11	4-11
Air Pressure	Back-flushing pressure need to be minimum 6 bar to maximum 8 bar	Back-flushing pressure need to be minimum (85 P.S.I) to maximum (115 P.S.I)

* Maximum operating pressure and temperature are interdependent parameters and are given for general reference only. Please consult your authorized Amiad representative for the application specific parameters.

Construction Materials	
Filter Housing & Lid	RPA (Reinforce Polyamide) or RPP (Reinforce Polypropylene)
Disc elements	PP (Polypropylene) or PA (Polyamide)
Backwash valves	RPA (Reinforce Polyamide) or RPP (Reinforce Polypropylene)
Manifolds	PP (Polypropylene)
Seals	NBR or EPDM, (Viton optional)
Control Tubing	PE or PA

Air Volume and Flow Rate at Different Pressures

Air Pressure...6-8 Bar (85-115 PSI)						
Water Pressure		Time Seconds	Air Flow Rate for one filter		Total Volume per one filter	
Bar	PSI		Ft ³ /MIN	Liter/Minute	Liter	Ft ³
6	84	7	9.5	269	33.6	1.18
3.5	50	7	9.5	269	38.1	1.3
1.5	20	7	11	311.5	45.7	1.6

**Recommendation Air Compressor: 3/4 H.P. + 80L /21Gl Tank.

5. Dimensional Drawing

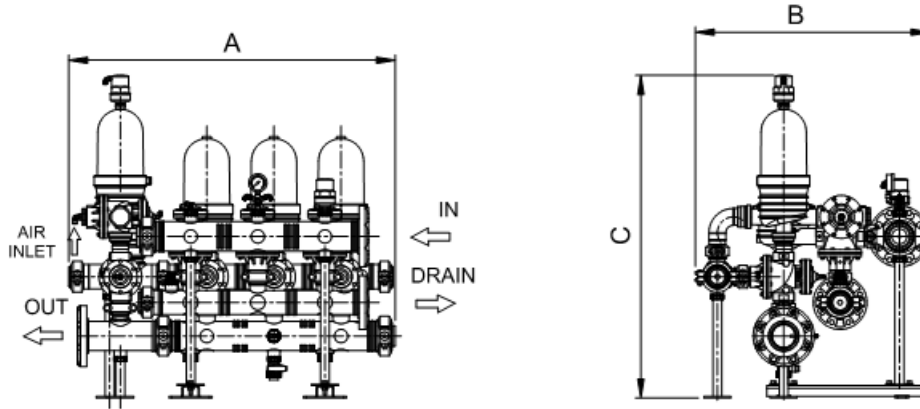

Description	Length	Height	Width
2-unit battery	840	1128	868
3-unit battery	1140	1128	868
4-unit battery	1440	1128	868
5-unit battery	1,740	1128	868
6-unit battery	2,040	1128	868
7-unit battery	2,340	1,178	921
8-unit battery	2,640	1,178	921

6. Installation & Start-up

Installation

- A. Check for any transport damage (The System operates under pressure!).
- B. Make sure that the inlet and outlet orientations are correct (shown by arrows on The System).
- C. Connect the Inlet, Outlet, Drain with their valves to the Main manifolds.
- D. Verify that all the covers clamps are properly closed!
- E. Connect and check the pressure source to the command solenoids of the PLC/Controller.
- F. Connect the Air pressure source to the Accumulator.

Start-up Operation

- If possible, do a dry test run (once or more) on all the system to be sure all connections and wiring are ok.
- Run the System by slowly open the inlet valve letting the Air from the system to vent out from the Air Release Valve on top of the Inlet manifold.
- Once the Air vents, check for leakages that can happen during transportation and installation.
- If the pressure difference is high, verify that the flow rate is not too high. An excessive flow rate through the filter causes excessive pressure loss.
- Open the Air supply and check the Air pressure in the Accumulator tank.
- Manually Start a back-flush cycle and make sure that all system components function correctly.
- If after the Back-flush the pressure difference is not reduced check if the flow is not too high, or the Air supply is too low (pressure/flow).

Note: PLC/Controllers are varied according to the Order.

PLC/Control

- Refer to the manufacturer's handbook before installing the PLC/Controller.
- Make sure that the voltage is correct BEFORE connecting it.
- Check that the ΔP hydraulic switch HIGH and LOW pressure tubes are correctly connected to the appropriate ports.
- Set the DP switch to the required ΔP (Recommended ΔP will be 5m/ 7PSI according to the site conditions).
- Set the PLC/Controller Back-flush Time to 7 seconds, Valve Delay to 1 second and the Dwell time to 25 seconds. These settings may require adjustment to conform to local water conditions. Typically, a 1 to 3-hour interval between back-flushes cycles is recommended.
- Typically, the Back-flush Cycle Time is a backup for the DP switch, it work in a way that whichever comes first reset the back-flush Cycle Timer. (Manual override will reset it too).

7. System Maintenance

General:

Before beginning any maintenance procedure, carefully read the safety & instructions in this document, make sure that all the workers at the filtration site are fully aware and comply with the safety instructions, these and any other local safety instructions.

7.1 General inspection of the filter module operation:

This is the visual basic general inspection procedure of the filter for proper operation. It should be done regularly and prior to any scheduled maintenance procedure.

Initiate a self-cleaning cycle and inspect the filters of the system for proper operation.

7.2 Weekly maintenance:

Visual Check:

- A. Check that the system operates properly by following the General Inspection of the Filter Operation as described above.
- B. Visually check the filter housing for leakage.
- C. Check the system for loosen bolts.

7.3 Maintenance prior to long term cessation of filter operation:

The following must be done if the system will not be operated for more than two weeks.

- A. Run a Back-flushing cycle.
- B. Release pressure from the filter system with the ball valve on the outlet manifold.
- C. Close and release the Air pressure from the Accumulator tank.
- D. Do a dry back wash (no water in the system, no Air supply to the accumulator).
- E. Close and disconnect the Air supply to the controller.

7.4 Maintenance prior to re-operation:

- A. Reconnect the system to the water and air supply, attach and open the air supply to the controller.
- B. Run a back-flush cycle, Check proper operation of the system.

7.5 Periodical:

Before beginning any maintenance procedure, carefully read the safety & instructions in this document, make sure that all the workers at the filtration site are fully aware and comply with the safety instructions, these and any other local safety instructions.

1. Perform a General Inspection of the system operation as described above and carefully inspect the filter visually for:
 - Proper operation
 - Any leakage from the filter housing or accessories
 - Abnormal or unusual noises
 - Loosen bolts
 - Any sign of corrosion on the filter housing or accessories
 - Unusual vibrations
 - Non-smooth operation of the filter air release valves and drainage ball valves.
2. Drain the system and release any water and pressure left in it.
3. Disassemble the filter's lids (As described in chapter 'Open the Filter for Service' in this document)
4. Inspect the filter internal components and seal for any wear and tear
5. Check the filter housing and lid for any sign of mechanical damage
6. Replace any damaged component
7. Make sure that your maintenance engineers are aware of even the slightest sign of damage to the filter housing, lid or accessories. In such case, please contact your Amiad representative immediately.
8. Re-assemble the filter's lids (As described in chapter 'Open the Filter for Service' in this document)
9. Perform a complete COMMISSIONING, START-UP AND FIRST OPERATION as described earlier in this document.

7.6 Service & Opening the Filter Lid:

Before beginning any maintenance procedure, carefully read the safety & instructions in this document, make sure that all the workers at the filtration site are fully aware and comply with the safety instructions, these and any other local safety instructions.

Tools & Accessories needed:

- Socket Wrench 1/2"
- Torque Meter Wrench set to 70 N-m
- Amiad Spin Klin Butterfly Nut Socket/Wrench
- Amiad Spin Klin Filtration Element Socket
- Silicon Grease

Preparations:

- Disconnect the system from the water supply and drain it via its 3/4" ball valve, live the valve open.
- Perform a general inspection of the system.

1. Re-Check that the system is not under pressure!

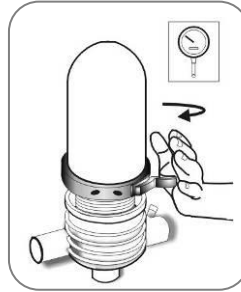

Figure 1

2. Carefully release the clamp and remove the lid. (Figure.1)

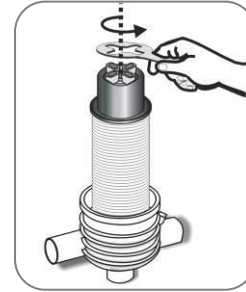

Figure 2

3. Unscrew the butterfly-nut on the filtration element. (Figure.2)

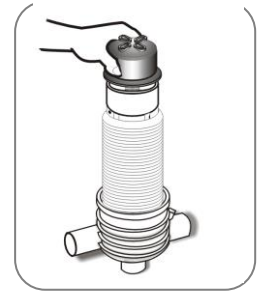

Figure 3

4. Remove the tightening cylinder. (Figure.3)

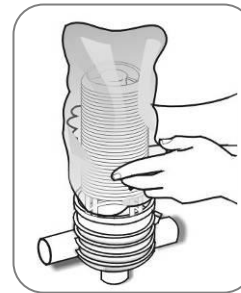

Figure 4

5. Remove the discs (for convenience we recommend using a plastic bag) (Figure 4, 5)

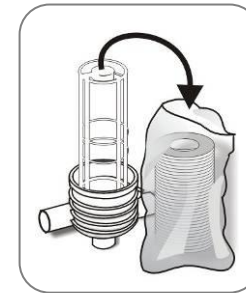

Figure 5

6. Tie each set on a string and place them in a cleaning solution (refer to 'Cleaning Recommendations' in this Document)

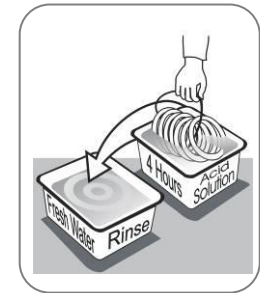

Figure 6

7. Thoroughly wash the discs with fresh water and then reassemble each set of discs on its spine (Figure 6).

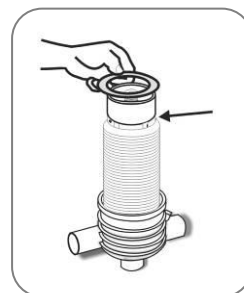

Figure 7

8. Check that the correct quantities of discs are assembled on the spine (Figure.7)

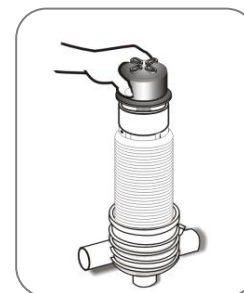

Figure 8

9. Put on the tightening cylinder and tighten the butterfly-nut. (Figure 8, 9)

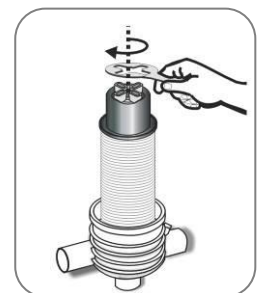

Figure 9

10. Reassemble the filter lid and tighten the clamp. (Figure 10, 11)

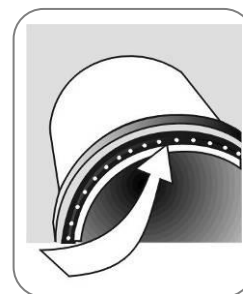

Figure 10

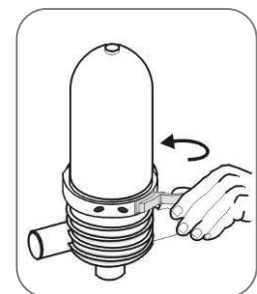

Figure 11

7.7 Cleaning Recommendations:

Cause for clogged Filtration Discs:

Water-formed deposits may cause clogging of the Filtration discs. The formation of these deposits depends on the quality of the water source and environmental conditions like temperature, pH, light, duration of filtration and more.

Common water-formed deposits are:

- Biological or organic deposits (mostly mucous or oily to the touch, beige, brown or green in color)
- Iron oxide (rust) or other metal oxides
- Carbonates (white or gray deposit)
- Combinations of the above

If these deposits cannot be eliminated by pretreatment of the water, we recommend the following cleaning procedure:

Material and Equipment:

- A well-ventilated working place.
- 2 small containers (1 liter), 2 large containers (15 liter) and a stirring stick, all resistant to chemicals, preferably of polypropylene.
- Plastic rope to tie up the disc.
- Sodium Hypochlorite NaOCl - Strong oxidizing liquid, commercial concentration: 10%. Oxidizes and removes organic and biological deposits.
- Hydrochloric Acid HCl - Very corrosive liquid, commercial concentration: 30%. Dissolves and removes carbonates, iron oxide, and other deposits.
- Safety equipment: safety glasses, gloves, long pants, long sleeved shirt and shoes.

ATTENTION !

While working with chemicals protect yourself with the necessary safety equipment:

- Safety glasses, gloves, protective clothing
- Work in a well-ventilated area
- Follow the manufacturer's instructions

Cleaning Organic and Biological Deposits:

- Open the filter and remove dirty discs.
- **Attention** – Never open the filter before the pressure has been released.
- Arrange the discs loosely on the plastic rope.
- Prepare a 5% Sodium Hypochlorite solution: pour 5 liters of water into one of the large containers add 5 liters of Sodium Hypochlorite (10%) into the water.
- Soak the discs in the solution so that both sides are covered. To achieve maximum cleaning, agitate the discs several times with a stirring stick.
- Contact time with cleaning solution: up to 8 hours.
- Remove the discs carefully from the solution, put them in the second large container and rinse them very well with clean water before placing them back in the filter.

- The recommendation is to wash the cleaned discs again in the filter to ensure that all chemical residues were removed.
- The cleaning solution can be used for several sets of discs. As the cleaning activity of the solution deteriorates, it may be necessary to soak the discs for a longer time

Cleaning Carbonates and Iron Deposits:

- Open the filter and remove the dirty discs.
- **Attention** – Never open the filter before the pressure has been released.
- Arrange the discs loosely on the plastic rope.
- Prepare a 5% Solution of Hydrochloric Acid: pour 10 liters of water into one of the large containers carefully add 2 liters of Hydrochloric Acid (30%) into the water.
- Soak the discs in the solution so that both sides will be covered.
- **NOTE:** Carbonates react violently with hydrochloric acid (foaming, gas evolution).
- To achieve maximum cleaning, agitate the discs several times with a stirring stick.
- Contact time with cleaning solution: 1 - 8 hours.
- Remove the discs carefully from the solution and rinse them well with clean water before placing them back in the filter.
- The recommendation is to wash the cleaned discs again in the filter to ensure that all chemical residues were removed.
- The cleaning solution can be used for several sets of discs. It may be necessary to soak the discs for a longer period of time as the cleaning activity of the solution deteriorates.

Cleaning Complex Deposits:

If the composition of the deposit is not known, perform the following test:

- Take 5 discs for the test.
- Soak 2 discs in a 5% Sodium Hypochlorite Solution.
- Preparation of the solution: pour 1 cup of water into a small container, then add 1 cup of Sodium Hypochlorite (10% NaOCl).
- Soak 2 discs in a 5% Hydrochloric Acid Solution.
- Preparation of the solution: pour 2½ cups (= 500ml) of water into a small container, then add carefully
- ½ cup (= 100ml) of Hydrochloric Acid (30% HCL).
- Keep one disc as a control.
- Observe the cleaning process: If one of the solutions removes all of the deposit, clean the discs in that solution according to the instructions above.
- If neither solution removes the deposit completely, continue with the test procedure.
- Remove the discs from both solutions, Wash them with running water and soak them in the second solution: put the two discs, which have been in the Sodium Hypochlorite Solution, in the Hydrochloric Acid Solution, and the other way around.
- Check the cleaning process: If one of the treatments removes all of the deposit, clean all of the discs following the same two-step procedure in the exact same order. Wash the discs well between the two cleaning processes.
- If the deposit hasn't been completely removed, send a set of untreated discs to the laboratory for further examination.

8. Troubleshooting

Continuous or Non-stop Backwashing:

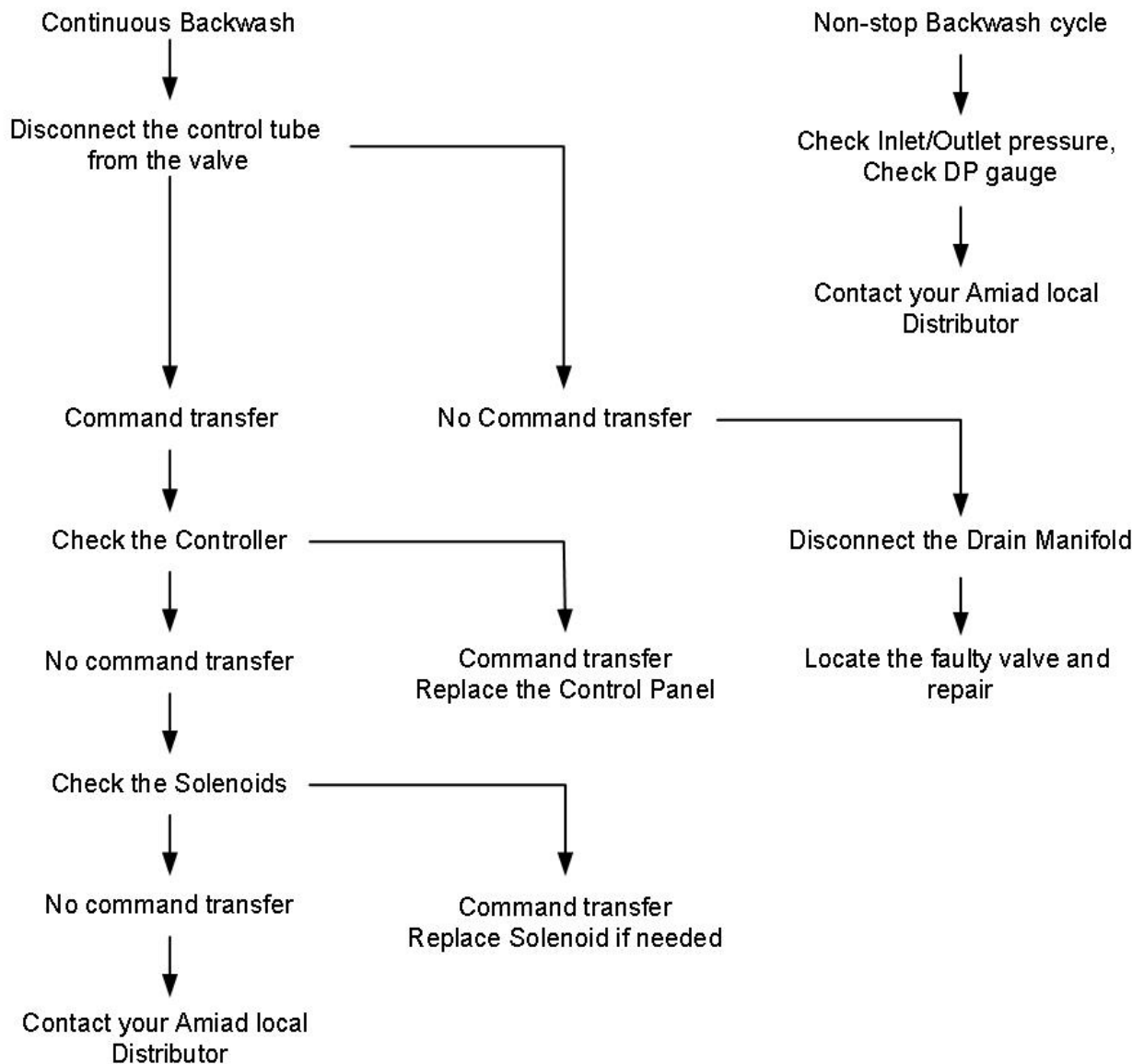

No Backwash Operation:

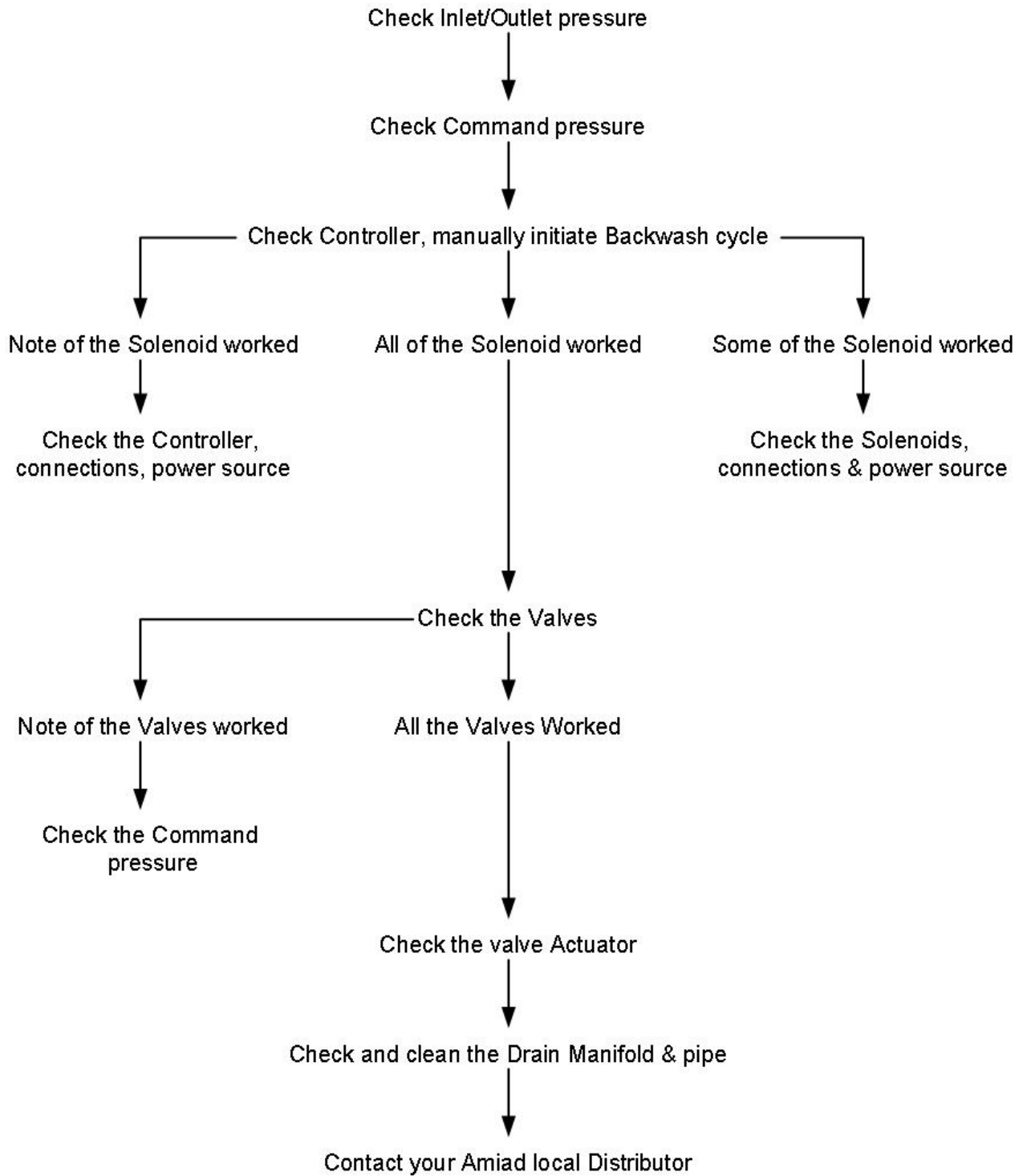

9. Control Scheme

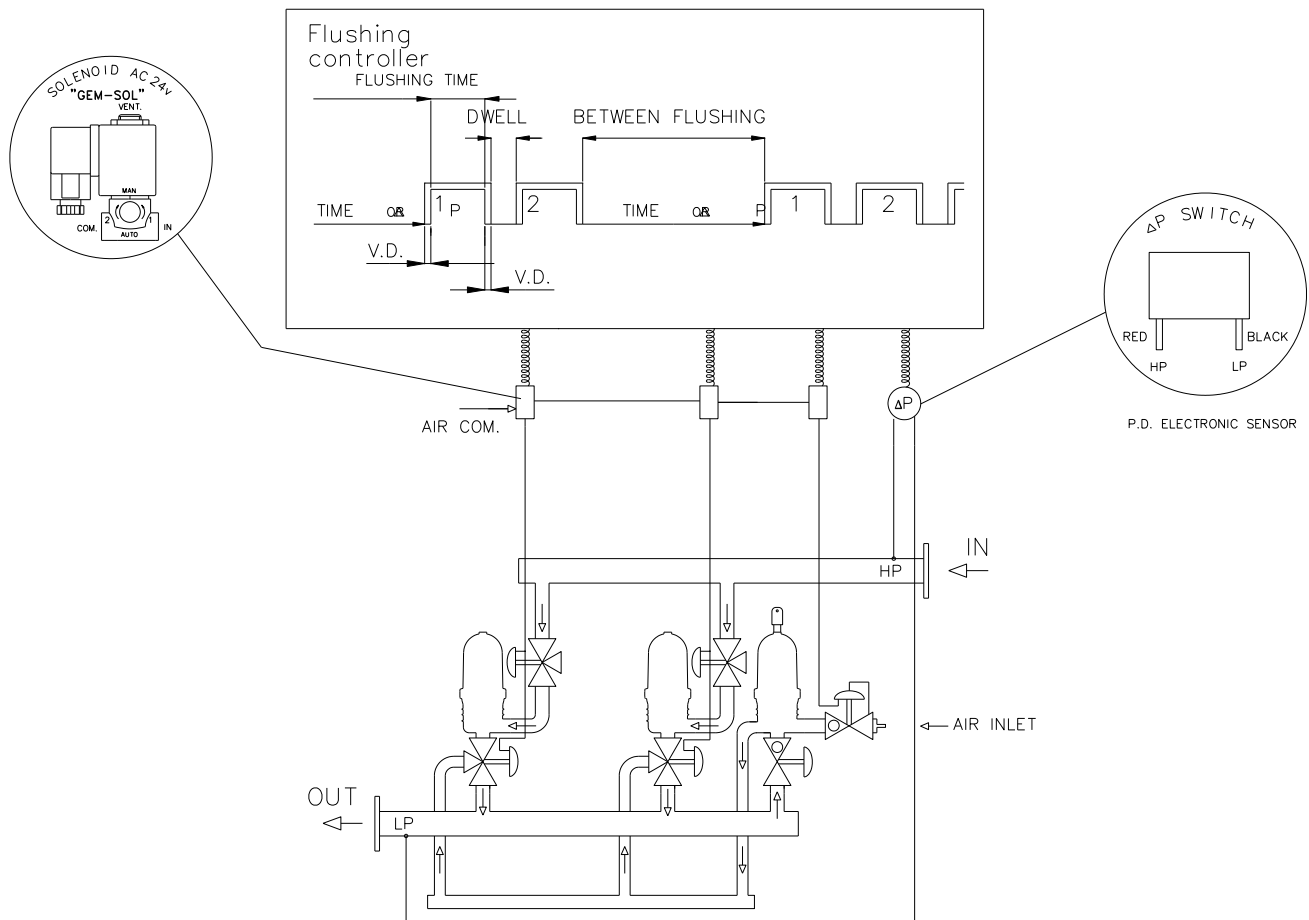

RECOMMENDED SETUP:

FLUSHING TIME:	7 sec.
DWELL:	15-25 sec.
V.D.:	1 sec.
BETWEEN FLUSHING:	1-2 hour.
ΔP	(3-4.5)m , (4-6) p.s.i.

10. FILTER PARTS SCHEDULE AND PARTS LIST

No.	Description	SAP P/N
1	COVER 2"-3" FILTER RPA	710103-005233
	COVER 2"-3" FILTER RPP DW	710103-004798
	2"-3" COVER PC TRANSPARENT	710101-000899
2	HYDRAULIC SEAL 2"-3" EPDM	770104-000248
	HYDRAULIC SEAL 2" NBR 70 SHORE	770104-000251
	HYDRAULIC SEAL 2"-3" VITON 70 SHRE	770104-000001
3	FILTER CLAMP 2"-3" S/ST304	760108-000002
4	SPINE ASSEMBLY MODEL 2.8 2-3" SK RPA	700101-002255
	SPINE ASSEMBLY MODEL 2.8 2-3" SK RPA AW	700101-002258
	SPINE ASSEMBLY MODEL 2.8 2-3" SK RPA SW	700101-002259
	SPINE ASSEMBLY MODEL 2.8 2-3" SK RPP EPDM SEALS DW	700101-002257
	SPINE ASSEMBLY MODEL 2.8 2-3" SK RPA LCE	700101-002256
4.1	2"SK BUTTERFLY NUT RPA BLACK	710101-000435
4.2	2"SK SPINE TIGHTENING NUT RPA BLACK	710101-000106
4.3	SK 2.7 SPINE PISTON HDPE NATURAL DW	710101-000436
4.4	ANTI FRICTION S/ST316 F/2.7SK DW	760109-000045
	ANTI FRICTION SUPER DUPLEX F/2.7SK DW	760109-000467
4.5	CONE MEMBRANE NATURAL 65 SHORE	770104-000372
	CONE MEMBRANE EPDM 70 SHORE 2.7SPIN KLIN DW	770104-000375
	CONE MEMBRANE NATURAL 65 SHORE LCE 2.8 SPINE SK	770104-000384
4.6	PARKER O-RING 2-237 EPDM 70 SHORE YELLOW DOT	770102-000034
5	2"-3"SK DISC SET DW (130 MICRON)	700101-001176
6	DISC ELEMENT PP 130MIC 2-3" SK RPA	700101-002267
7	BODY 2" SK BATTERY RPA GRV	710103-006082
	BODY 2" SK BATTERY RPA BSPT	710103-006080
8	WRENCH GALVANIZED F/BUTTERFLY NUT	760109-000055

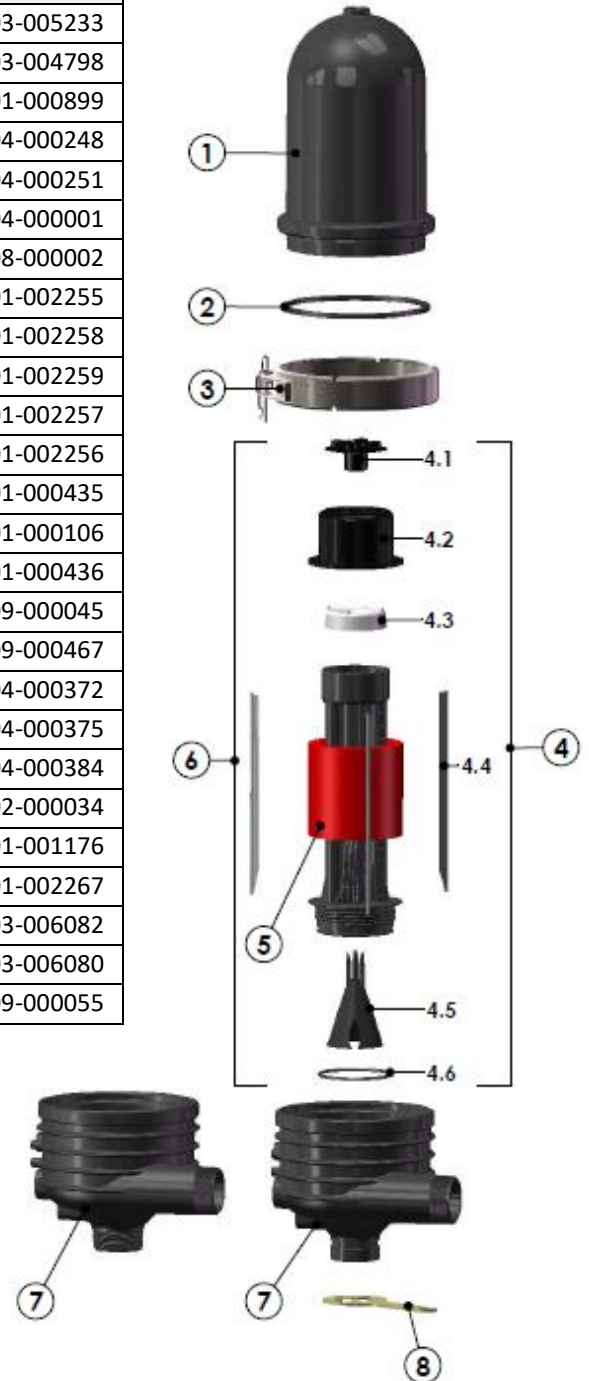

11. VALVES - PARTS SCHEDULE AND PARTS LIST

350 Series Plastic Back-flush Filter Valve - Double Chamber Straight/Angle & Reverse Flow Size: 2"x2"

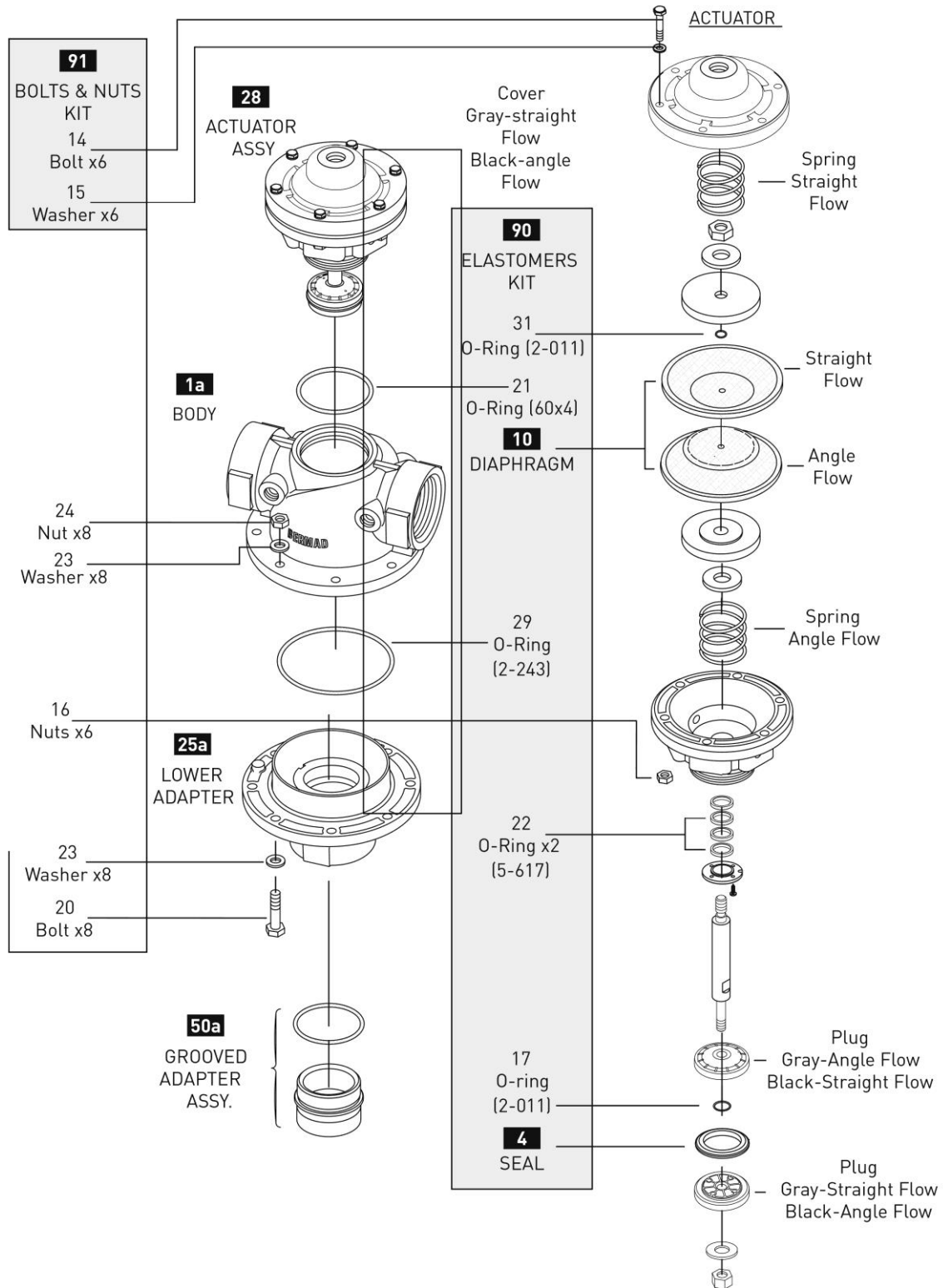

11.1 STANDARD VALVES PARTS LIST

STRAIGHT FLOW 2X2 350 BSP RPA BLACK BERMAD

730102-000169

No.	Description	SAP
1a	BODY ASSY. F/2" STRAIGHT FLOW BERMAD	730113-000317
25a	LOWER ADAPTOR F/2" STRAIGHT FLOW PLASTIC BERMAD	730113-000315
28	VALVE ASSY. F/2" STRAIGHT FLOW PLASTIC BERMAD	730113-000507
50a	ADAPTATION KIT FOR THREAD-VICTAULIC,2"BS	760190-000074
90	SEALS + DIAPHRAGM KIT F/2" 350 BERMAD	730113-000763
10	DIAPHRAGM F.2*2 VALVE	730113-000446
4	PLUG SEAL F.2*2PL.STR.VALVE	730113-000324
91	BOLTS-NUTS KIT F/2" 350 BERMAD	730113-000761

STRAIGHT REVERSE FLOW 2X2 350 BSP RPA BLACK BERMAD

730102-000173

No.	Description	SAP
1a	BODY ASSY. F/2" STRAIGHT FLOW BERMAD	730113-000317
25a	LOWER ADAPTOR F/2" STRAIGHT FLOW PLASTIC BERMAD	730113-000315
28	VALVE ASSY. F/2" STRAGHT REVERSE FLOW PLASTIC BERMAD	730113-000338
50a	ADAPTATION KIT FOR THREAD-VICTAULIC,2"BS	760190-000074
90	SEALS + DIAPHRAGM KIT F/2" 350 BERMAD	730113-000763
10	DIAPHRAGM F.2*2 VALVE	730113-000446
4	PLUG SEAL F.2*2PL.STR.VALVE	730113-000324
91	BOLTS-NUTS KIT F/2" 350 BERMAD	730113-000761

11.2 DW VALVES PARTS LIST

STRAIGHT FLOW 2X2 350 BSP RPA BLACK BERMAD DW

730102-000283

No.	Description	SAP
1a	BODY ASSY. F/2" 350 BLACK PLASTIC BERMAD BSP DW	30113-000872
25a	LOWER ADAPTOR F/2" 350 BLACK PLASTIC BERMAD BSP DW	730113-000873
28	ACTUATOR ASSY. F/2" STRAIGHT FLOW PLASTIC BERMAD DW	730113-000871
50a	ADAPTOR+SEAL F/2" 350 BLACK PLASTIC BERMAD GRV/TRH DW	730113-000883
90	ELASTOMERS KIT F/2" 350 BERMAD DW	730113-000867
10	DIAPHRAGM F/2" STRAIGHT FLOW BERMAD	730113-000446
4	SEAL F/2" VALVE EPDM BERMAD DW	730113-000881
91	BOLTS-NUTS KIT F/2" 350 BERMAD	730113-000761

STRAIGHT REVERSE FLOW 2X2 350 BSP RPA BLACK BERMAD DW

730102-000284

No.	Description	SAP
1a	BODY ASSY. F/2" 350 BLACK PLASTIC BERMAD BSP DW	30113-000872
25a	LOWER ADAPTOR F/2" 350 BLACK PLASTIC BERMAD BSP DW	730113-000873
28	ACTUATOR ASSY. F/2" STRAIGHT REVERSE FLOW PLASTIC BERMAD DW	730113-000870
50a	ADAPTOR+SEAL F/2" 350 BLACK PLASTIC BERMAD GRV/TRH DW	730113-000883
90	ELASTOMERS KIT F/2" 350 BERMAD DW	730113-000867
10	DIAPHRAGM F/2" STRAIGHT FLOW BERMAD	730113-000446
4	SEAL F/2" VALVE EPDM BERMAD DW	730113-000881
91	BOLTS-NUTS KIT F/2" 350 BERMAD	730113-000761

11.3 AW VALVES PARTS LIST

STRAIGHT FLOW 2X2 350 BSP RPA BLACK AGRESSIVE WATER BERMAD

730102-000108

No.	Description	SAP
1a	BODY ASSY. F/2" 350 PLASTIC BERMAD WA	730113-000759
25a	LOWER ADAPTOR F/2" STRAIGHT FLOW PLASTIC BERMAD WA	730113-000332
28	VALVE ASSY. F/2" STRAIGHT FLOW PLASTIC BERMAD WA	730113-000331
50a	ADAPTATION KIT FOR THREAD-VICTAULIC,2"BS	760190-000074
90	SEALS + DIAPHRAGM KIT F/2" 350 BERMAD	730113-000763
10	DIAPHRAGM F.2*2 VALVE	730113-000446
4	PLUG SEAL F.2*2PL.STR.VALVE	730113-000324
91	BOLTS-NUTS KIT F/2" 350 BERMAD WA	730113-000762

STRAIGHT REVERSE FLOW 2X2 350 BSP RPA BLACK AGRESSIVE WATER BERMAD

730102-000115

No.	Description	SAP
1a	BODY ASSY. F/2" 350 PLASTIC BERMAD WA	730113-000759
25a	LOWER ADAPTOR F/2" STRAIGHT FLOW PLASTIC BERMAD WA	730113-000332
28	VALVE ASSY. F/2" STRAGHT REVERSE FLOW PLASTIC BERMAD WA	730113-000345
50a	ADAPTATION KIT FOR THREAD-VICTAULIC,2"BS	760190-000074
90	SEALS + DIAPHRAGM KIT F/2" 350 BERMAD	730113-000763
10	DIAPHRAGM F.2*2 VALVE	730113-000446
4	PLUG SEAL F.2*2PL.STR.VALVE	730113-000324
91	BOLTS-NUTS KIT F/2" 350 BERMAD WA	730113-000762

11.4 SW VALVES PARTS LIST

STRAIGHT FLOW 2X2 350 BSP RPA/DUPLEX BLACK SW BERMAD

730102-000106

No.	Description	SAP
1a	BODY ASSY. F/2" 350 PLASTIC BERMAD WA-DUPLEX-S/S316	730113-000754
25a	LOWER ADAPTOR F/2" 350 PLASTIC BERMAD WA-DUPLEX-S/S316	730113-000753
28	ACTUATOR F/2" STRAIGHT FLOW BERMAD WA-S. DUPLEX	730113-000589
50a	ADAPTATION KIT FOR THREAD-VICTAULIC,2"BS	760190-000074
90	SEALS + DIAPHRAGM KIT F/2" 350 BERMAD	730113-000763
10	DIAPHRAGM F.2*2 VALVE	730113-000446
4	PLUG SEAL F.2*2PL.STR.VALVE	730113-000324
91	BOLTS-NUTS KIT F/2" 350 BERMAD WA	730113-000762

STRAIGHT REVERSE FLOW 2X2 350 BSP RPA/DUPLEX BLACK SW BERMAD

730102-000113

No.	Description	SAP
1a	BODY ASSY. F/2" 350 PLASTIC BERMAD WA-DUPLEX-S/S316	730113-000754
25a	LOWER ADAPTOR F/2" 350 PLASTIC BERMAD WA-DUPLEX-S/S316	730113-000753
28	ACTUATOR F/2" STRAGHT REVERSE FLOW BERMAD WA-SUPER DUPLEX	730113-000590
50a	ADAPTATION KIT FOR THREAD-VICTAULIC,2"BS	760190-000074
90	SEALS + DIAPHRAGM KIT F/2" 350 BERMAD	730113-000763
10	DIAPHRAGM F.2*2 VALVE	730113-000446
4	PLUG SEAL F.2*2PL.STR.VALVE	730113-000324
91	BOLTS-NUTS KIT F/2" 350 BERMAD WA	730113-000762

12. SYSTEM DRAWINGS (to be amended per each specific ordered)

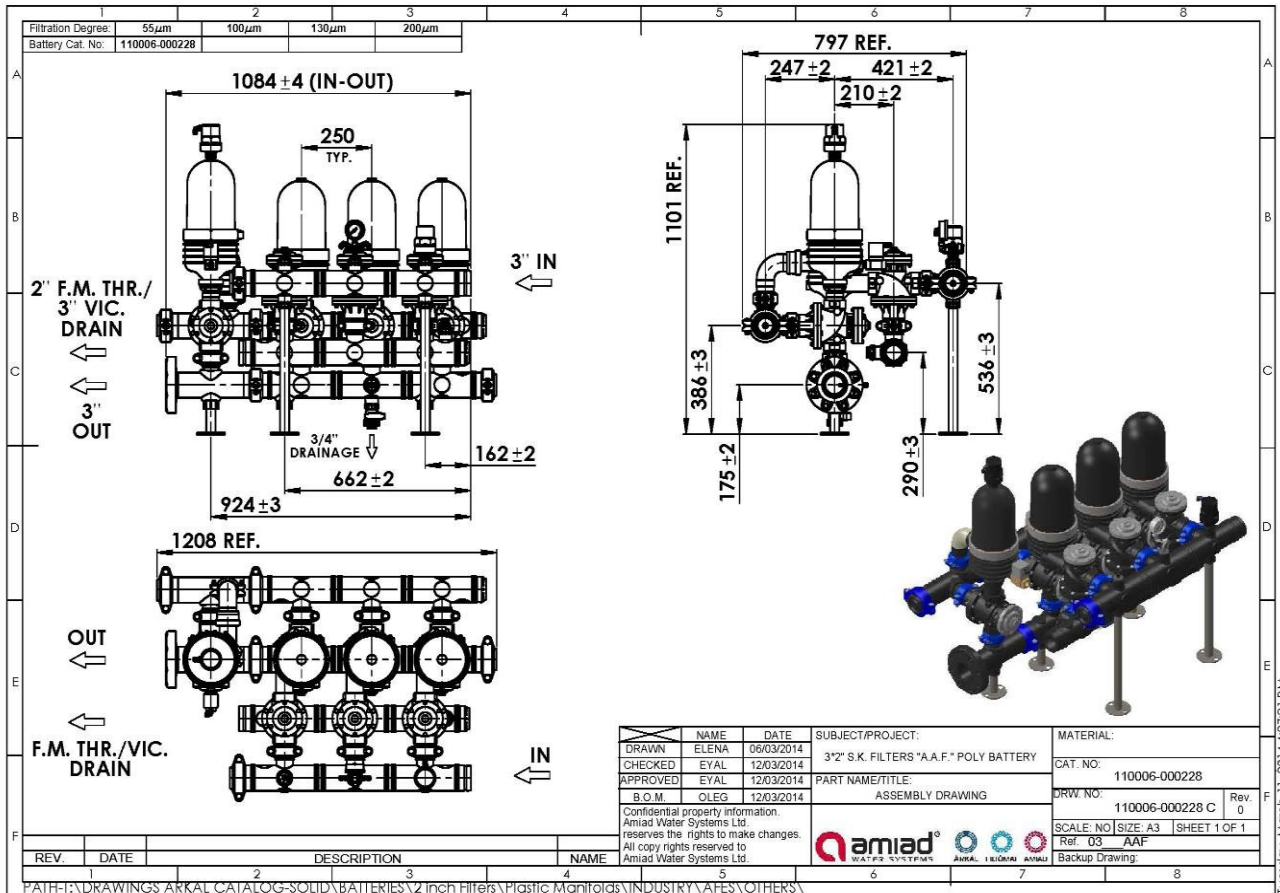

13. AMIAD LIMITED WARRANTY

1. This certificate applies to Amiad Water Systems Ltd. ("**Amiad**") products purchased by you (the "**Buyer**") from Amiad unless specifically agreed otherwise in writing by Amiad. This Warranty extends only to the original purchaser, and is not transferable to anyone who subsequently purchases, leases, or otherwise obtains the product from the original purchaser.
2. Amiad hereby warrants that the products are and will be free from defects in material and workmanship under normal use and service. Amiad warrants that it will correct manufacturing defects in the products, in accordance with the conditions set out in this Warranty.
3. This Warranty is enforceable for a period of 12 months after the date upon which the products were delivered (the "**Warranty Period**").
4. In the event that during the Warranty Period the Buyer discovers a defect in material and/or workmanship in any product or part (the "**Defective Product**"), it shall submit a written complaint to Amiad using Amiad's standard Buyer Complaint Form. For the receipt of the Buyer Complaint Form, the submission of the complaint or any questions please contact your service representative.
5. Upon written demand by Amiad the Buyer shall return the Defective Product - or a sample thereof - to Amiad, at Amiad's cost. If the Buyer ships any such Defective Product, Amiad suggests the Buyer package it securely and insure it for value, as Amiad assumes no liability for any loss or damage occurring during shipment. Provided however that in the event Amiad determines that this Warranty does not apply to such product, Buyer shall promptly reimburse Amiad for such cost (including freight and customs). Any returned product or part must be accompanied by the Warranty certificate and the purchase invoice. It is clarified that the Buyer may not return the Defective Product unless such return was coordinated and approved by Amiad in advance.
6. Amiad's obligation under this Warranty shall be limited to, at Amiad's option, the repair or exchange, free of charge, of the product or any part which may prove defective under normal use and service during the Warranty Period. The provision of a repair or replacement of a product during the Warranty Period will result in an extension of the Warranty Period by an additional period of 12 months, provided that the total accumulated Warranty Period shall in any event be no more than 18 months from the date upon which the products were delivered.
7. This Warranty is valid on the condition that the products are installed according to Amiad's instructions as expressed in Amiad's instruction manuals and according to the technical limitations as stipulated in Amiad's literature or as stated by a representative of Amiad.
8. This Warranty will not apply to damaged or defective products resulting from or related to:
 - (i) Fire, flood, power surges or failures or any other catastrophe and/or unforeseen occurrence, such as but not limited to those for which the Buyer is customarily insured for, or any force majeure events;
 - (ii) Fault, abuse or negligence of the Buyer;
 - (iii) Intake water not meeting the agreed standards, as set forth in a written document, approved by Amiad, or improper storage;
 - (iv) Improper or unauthorized use of the product or related parts by the Buyer, including Buyer's failure to operate the product in conformity with the recommendations and instructions of Amiad, as set forth in Amiad's manuals and other written materials, the operation of the product other than by a trained and qualified operator, or improper installation of the product by a third party not authorized by Amiad;
 - (v) Performance by the Buyer of maintenance or operation other than in conformity with the recommendations and instructions of Amiad, or other than in accordance with procedures defined in the literature supplied for products (including the timely replacement of requisite parts), and for services provided other than by a trained and qualified advanced operator; or
 - (vi) Any alteration, modification, foreign attachment to or repair of the products, other than by Amiad or its authorized technical representatives.
9. In no event shall Amiad be liable to the Buyer or any third party for any damages to property, or for any intangible or economic loss, including loss of profits, loss of customers or damage to reputation, for any damages, including indirect, special, consequential damages, or punitive damage arising out of or in connection with this Warranty, or arising out of or in connection with the product's performance or failure to perform, even if it has been advised of the possibility of such damages.
10. Amiad will be excused for failure to perform or for delay in performance hereunder if such failure or delay is due to causes beyond its reasonable control or force majeure preventing or hindering performance.
11. This Warranty set forth herein is the only contractual warranty given by Amiad and is provided in lieu of any other warranties created by any documentation, packaging or otherwise.
12. Amiad makes no warranty whatsoever in respect to accessories or parts not supplied by Amiad. In the event that Amiad is required to correct a Defective Product or product not covered by this Warranty, it will do so solely in consideration for additional fees.
13. The parties will actively endeavor to amicably settle any dispute arising between them. In the event that the parties are unable to reach an equitable settlement of such dispute, any claim or lawsuit related to the Warranty, its validity execution, its performance be brought before only the courts of Tel-Aviv, Israel. Israeli law will govern the Warranty, to the exclusion of any conflict of law rules.



Manufacturer

Amiad Water Systems Ltd. D.N. Galil Elyon 1, 1233500, Israel.
Tel: +972 4690 9500 | Fax: +972 48141159 | Email: info@amiad.com

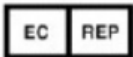

European Authorised Representative for CE

Obelis s.a. Bd Général Wahis 53, 1030 Brussels, Belgium.
Tel: +(32) 2732 5954 | Fax: +(32) 27326003 | Email: mail@obelis.net

EU Declaration of Conformity

<https://www.amiad.com/certificatesDownload.asp>